

# Class 3: How to File for a Patent

TVE2 IP Series

Thursday, May 2, 2013

**Russell Jeide & Scott Cromar**

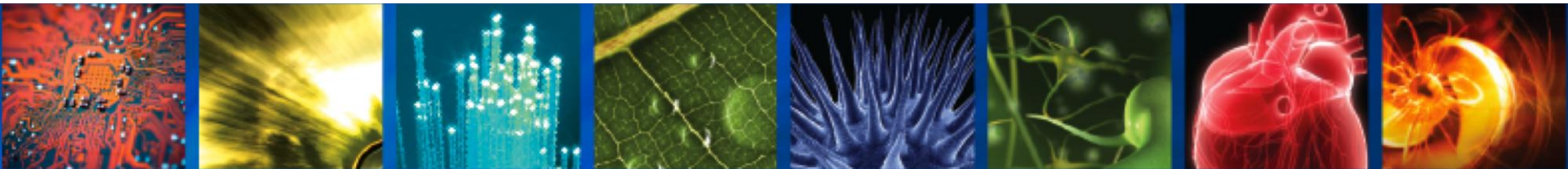

# TVE2 Intellectual Property (IP) Series

- **Class 1:** "What intellectual property is, and why it may be important to your startup"
  - ~~Class 2:~~ "How to enter the patent world strategically and economically"
  - **Class 3:** "How to file for a patent"
  - **Class 4:** "The meaning of patent infringement and patent litigation"
  - **Class 5:** "How to use copyrights, trademarks, and trade secrets to your advantage"
  - **Class 6:** TBA (probably continuation of Class 5)
- 

# Russell Jeide

- Patent Attorney for 12 years
- Partner at Knobbe Martens
- B.S. Electronics Engineering Technology
- Specializes in patent prosecution, legal opinion work, and licensing
- Experience in telecommunication systems, computer architecture, computer software, Internet business methods, and mechanical devices



# Scott Cromar

- Patent Agent for 3 years; Patent Attorney for 1
- Associate at Knobbe Martens
- B.S. Electrical Engineering; M.S. Electrical and Computer Engineering
- Specializes in IP counseling and patent preparation and prosecution
- Experience with software, computers, electronics, and semiconductors



# Disclaimer

- **This presentation is for information purposes only and does not constitute legal advice.**
- **This presentation does not establish any form of attorney-client relationship.**

# Today:

- Prior Art Searching
- Types of Patents
  - Utility vs. Design
  - Provisional vs. Non-provisional
- Application Timeline & Costs
- Preparing & Filing the Documents
- After Filing
- Considerations for Hiring an Attorney

# Prior Art Searching

# Prior Art Searching

- No obligation to conduct search
- Benefits:
  - Evaluate available scope of protection before filing
  - Write more focused patent application
  - Potentially strengthen validity of patent
  - Learn about patents you may infringe
- Administer carefully to avoid damaging communications



# Searching Resources

- [patft.uspto.gov](http://patft.uspto.gov)
- [patents.google.com](http://patents.google.com)
- [freepatentsonline.com](http://freepatentsonline.com)
- [espacenet.com](http://espacenet.com)
- [Patentlens.net](http://Patentlens.net)

The screenshot shows the homepage of the United States Patent and Trademark Office's Patent Full-Text Databases. The header includes the USPTO logo and the text "United States Patent and Trademark Office" and "An Agency of the Department of Commerce". The main content is organized into three columns:

- PatFT: Patents** (Full-Text from 1976):
  - [Quick Search](#)
  - [Advanced Search](#)
  - [Number Search](#)
  - [View Full-Page Images](#)
  - [PatFT Help Files](#)
  - [PatFT Status, History](#)
  - [PatFT Database Contents](#)
  - [Report Problems](#)
- << BOTH SYSTEMS >>** (The databases are operating normally):
  - [Notices & Policies](#)
  - [How to View Images](#)
  - [Assignment Database](#)
  - [Public PAIR](#)
  - [Searching by Class](#)
  - [Sequence Listings](#)
  - [Attorneys and Agents](#)
  - [Privacy Policy](#)
- AppFT: Applications** (Published since March 2001):
  - [Quick Search](#)
  - [Advanced Search](#)
  - [Number Search](#)
  - [View Full-Page Images](#)
  - [AppFT Help Files](#)
  - [AppFT Status, History](#)
  - [Report Problems](#)

2 Last modified: 8/26/2010

# Types of Searches

- Patentability
- Landscape
- “Risk of Liability”

# Patentability Search

- When useful: When you are thinking of filing a patent application on a specific idea and you want a brief overview of other patents, patent applications, and articles that may disclose the same (or very similar) idea.
- What will you gain: You'll have an idea of whether your idea is new or if someone else has already publicly disclosed the idea. You'll also see if others have disclosed ideas somewhat similar to yours such that you may want to focus your patent application on the benefits and advantages that distinguish your idea from the other similar ideas.

# Landscape Search

- When useful: When you are planning on going into a new area and would like to know about the general patent landscape.
- What will you gain: You'll receive a listing of issued patents and patent publications in the general field you specified. This can let you know (a) who are the big players IP-wise in this field, (b) how populated is the field already with patents and patent applications, (c) what are the problems being addressed in the various patents, and (d) does there seem to be room for you to move in?

# “Risk of Liability” Search

- When useful: When you are getting serious about developing/launching a new product and you would like to understand the risk of infringing someone else's existing patents.
- What will you gain: You'll receive an overview of existing issued U.S. patents, and specifically of their claims, which are close to your subject matter and might cover your new product. Thus, you may have an opportunity to (a) determine that there is a low risk of liability, or, if need be, (b) revise your plans according to what the search results revealed and/or (c) further research potential weaknesses in the existing issued patents identified by the search.

# Types of Patents

# Review: What is a Patent?

- Right to exclude others from practicing your invention
  - Not a right to use, make, or sell
  - You may still infringe others' patents
- Two types:
  - **Utility Patent:** protect functionality (how it works)
  - **Design Patent:** protect ornamental appearance

# Review: Utility vs. Design Patents

- **Utility**
  - Protection for functionality, how something works
  - Last for 20 years from date of priority (usually the filing date)
- **Design**
  - Protect ornamental appearance of an industrial article
  - Lasts 14 years (soon to be 15 years)
- **Examples**



# Review: Provisional vs. Non-provisional

## PROVISIONAL

---

- Not published

---

- Expires after 12 months

---

- Cannot become a patent

---

- No formatting guidelines

---

- Claims not required

---

- Contributors identified

---

## REGULAR (NON-PROVISIONAL)

---

- Published unless request for non-publication is filed with application

---

- Remain pending until reviewed by the PTO

---

- Can become a patent

---

- Strict formatting

---

- Claims required

---

- Inventors identified based on claims

---

# Requirements for Patentability

- Patentable subject matter
  - “process, machine, manufacture, or composition of matter, or any new and useful improvement thereof”
  - Anything under the sun made by man
- Novel and non-obvious in view of prior art
- Enablement
- Best Mode
- Utility

# Ownership of Patents

- The **inventors** are the presumptive owners of a patent
  - Inventors are those who contributed to **conception** of the invention, not merely **reduction to practice**
- Be Aware:
  - Written assignment
  - Employee hired to invent
  - Fiduciary duty to assign inventions

# Application Timeline & Costs

# When Should the Application Be Filed

- For protection in the United States
  - Best Case: Before Disclosure
  - Backup: Within 1 year of disclosure (but rights may already be lost in certain circumstances)
- For protection in most foreign countries
  - Before **any** public disclosure
- No requirement that a product or prototype be developed
- A nondisclosure agreement (NDA) should be used when possible

# Tips for Filing – File Early!

- You can and should file a patent application as soon as you can describe a valuable invention.
- You don't need to develop a product or a prototype before filing.
- You can lose patent rights by waiting even when there is no deadline.
- When two inventors file for the same invention, the patent office usually awards the patent to the first to file.

# U.S. Patent Prosecution Timeline

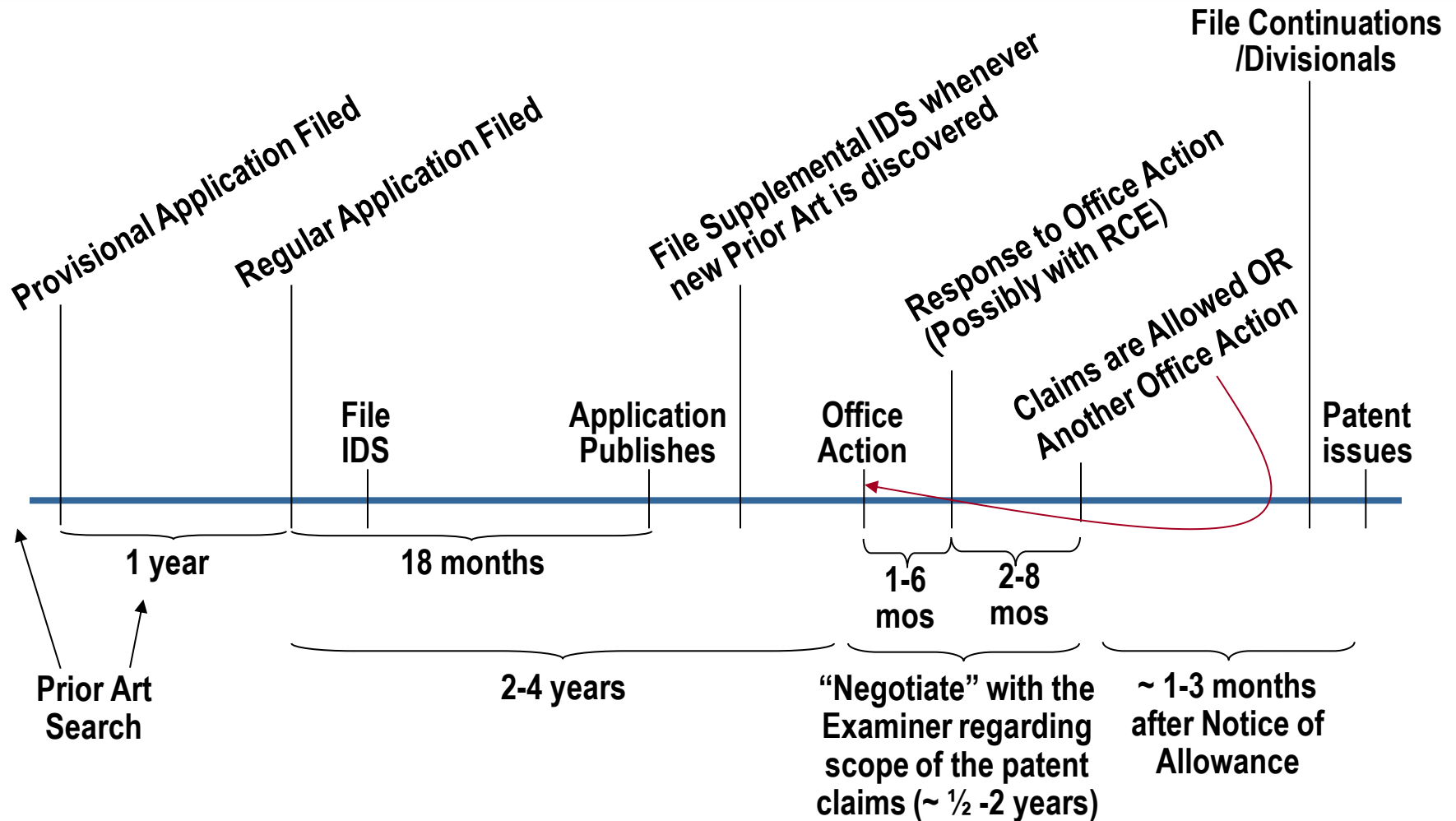

# Foreign Priority

- Foreign patents must be filed within one year of U.S. filing date in order to claim “priority”



# Duty of Disclosure

- File Information Disclosure Statement (IDS)
- Any material information known by:
  - Inventors;
  - Patent attorneys; and
  - People directing patent prosecution
- Any time during pendency
- Failure to disclose can result in unenforceable patent

# Preparing and Filing the Documents

# Application Components

- **Specification**
  - Title
  - Background
  - Summary
  - Brief Description of Drawings
  - Detailed Description
  - Claims
  - Abstract
- **Figures/Drawings**

# Example: Title & Background (p. 1)

SEPHRA.003A

PATENT

## FOUNTAIN THAT FLOWS WITH FLUIDIC MATERIAL

### Background of the Invention

#### Field of the Invention

[0001] The invention relates generally to a food dispensing apparatus, and more particularly to a fountain that flows with a fluidic material.

#### Description of the Related Art

[0002] Fondue machines typically include a bowl shaped container for holding and heating chocolate. The container is heated by a heating element to melt the chocolate. Fruit, or other food items, may then be dipped into the container of the fondue machine.

[0003] In recent years, fondue machines have taken on alternate configurations. For example, Design & Réalisation Inc. in Montreal, Canada markets a chocolate fountain that moves melted chocolate so that it flows over a number of tiers like a fountain. Figure 1 is a diagram illustrating a prior art chocolate fountain 100, such as the fountain marketed by Design & Réalisation Inc. As shown in Figure 1, the chocolate fountain 100 includes a container 110 configured to hold and melt chocolate. A hollow barrel 120 is mounted in the center of the container 110 and provides a pathway for melted chocolate to be moved upward, through its hollow center, to the top of the fountain. An auger including a spiral flight extending around the length of the auger is mounted within the hollow barrel 120. The auger

# Example: Summary (p. 3)

## Summary of the Invention

[0009] In one embodiment, an apparatus comprises a basin having a bottom surface and an outer side surrounding the bottom surface, the basin being configured to contain a fluidic material within the basin, a high thermal conductivity enclosure substantially encasing a heating element, wherein the enclosure is in contact with the bottom surface of the basin and is configured to substantially evenly heat the bottom surface of the basin, a cylinder having a top end and a bottom end, wherein the bottom end is attached to the bottom surface of the basin so that the cylinder extends substantially perpendicular from the bottom surface, an auger having a spiral flight comprising a plurality of revolutions protruding along a length of the auger, wherein the auger is disposed within the cylinder, a tier removably attached to the cylinder and having an upper surface and a lower surface, and a source of rotation coupled to the auger and configured to rotate the auger inside the cylinder, wherein the spiral flight supports the fluidic material as the auger rotates, moving the fluidic material upwardly to the top end of the cylinder.

# Example: Brief Desc. of Drawings (p. 8)

## Brief Description of the Drawings

[0023] Figure 1 is a side elevation view of a prior art chocolate fountain.

[0024] Figure 2 is a cross-sectional side view of a chocolate fountain having features that reduce cleaning time and improve performance

[0025] Figure 3 is a cross-sectional side elevation view of a single structure crown.

[0026] Figure 4A is a cross-sectional side elevation view of a tier that may be attached to the cylinder to direct the flow of the melting chocolate.

[0027] Figure 4B is a cross-sectional side view of a cylinder including score marks indicating the recommended positions for placing the tiers.

[0028] Figure 5 is a pictorial flow diagram illustrating the assembly of a tier using a flanging, or riveting, process.

[0029] Figure 6 is a side view of the auger, including a central shaft and a spiral flight.

[0030] Figure 7 is a cross-sectional side elevation view of another embodiment of a chocolate fountain.

[0031] Figure 8 is a cross sectional side elevation view of an exemplary tier that

# Example: Detailed Description (p. 9)

## Detailed Description of Preferred Embodiments

[0035] Embodiments of the invention will now be described with reference to the accompanying Figures, wherein like numerals refer to like elements throughout. The terminology used in the description presented herein is not intended to be interpreted in any limited or restrictive manner, simply because it is being utilized in conjunction with a detailed description of certain specific embodiments of the invention. Furthermore, embodiments of the invention may include several novel features, no single one of which is solely responsible for its desirable attributes or which is essential to practicing the inventions herein described.

[0036] **Figure 2** is a cross-sectional side view of an improved fountain 200 having features that address the disadvantages discussed above with respect to the prior art. The improved fountain 200 advantageously has reduced cleaning requirements, improved performance, and simpler set-up. In one embodiment, the fountain 200 flows with melted chocolate and is therefore referred to as a chocolate fountain 200. However, while reference is made herein to the use of chocolate in the fountain 200, the systems and methods described herein are not limited to the use of chocolate. Accordingly, references made herein to a chocolate fountain do not limit the fountain to use with chocolate. In particular, any other fluidic material which a user wishes to circulate through the fountain 200 may be used instead of chocolate. For example, other confectionery items, such as caramel, toffee, taffy, or marshmallows; dairy products, such as cheese; or flavorings, such as mint or fruit, may be

# Example: Abstract (p. 28)

## **FOUNTAIN THAT FLOWS WITH FLUIDIC MATERIAL**

### Abstract of the Disclosure

A fountain for heating and distributing fluidic material is manufactured using various processes and materials so that the fountain is more easily cleaned and sanitized, has improved performance, and is easier to assemble. In one embodiment, the chocolate fountain includes a heating element encased in an aluminum enclosure. A basin containing chocolate is heated by contact with the aluminum enclosure. Because the aluminum enclosure has a relatively high thermal conductivity, the basin is heating substantially uniformly, thus reducing the occurrence of hot spots. Additionally, a plastic auger having a spiral flight rotates and lifts the melted chocolate upward to a top end of cylinder that houses the auger. The use of a plastic auger advantageously eliminates welding artifacts on the auger, such as burrs and pits, on which melted chocolate may accumulate. Accordingly, the plastic auger is easy to clean. A smaller chocolate fountain that may advantageously be more suitable for home use is also described herein.



# Claims

- Numbered paragraphs which define scope of protection
- For non-provisional app must include at least 1!
- Example Types
  - Apparatus
  - System
  - Method

# Example: Claims (p. 21)

## WHAT IS CLAIMED IS:

1. An apparatus comprising:

a basin having a bottom surface and an outer side surrounding said bottom surface, said basin being configured to contain a fluidic material within said basin;

a high thermal conductivity enclosure substantially encasing a heating element, wherein said enclosure is in contact with said bottom surface of said basin and is configured to substantially evenly heat said bottom surface of said basin;

a cylinder having a top end and a bottom end, wherein said bottom end is attached to said bottom surface of said basin so that said cylinder extends substantially perpendicular from said bottom surface;

an auger having a spiral flight comprising a plurality of revolutions protruding along a length of said auger, wherein said auger is disposed within said cylinder;

a tier removably attached to said cylinder and having an upper surface and a

# Figures/Drawings

- Block diagrams
- Schematics
- Structural illustrations
- Flow charts
- Screen shots

# Example: Structural Figure

3 / 9

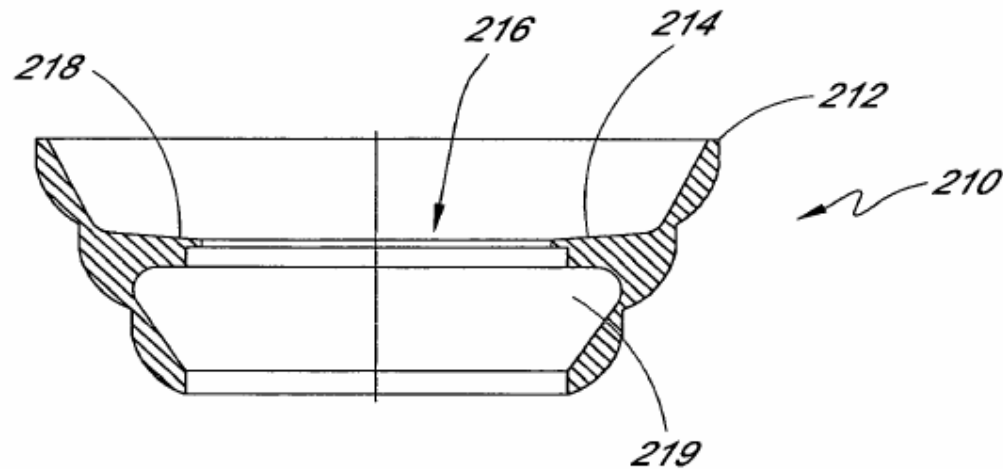
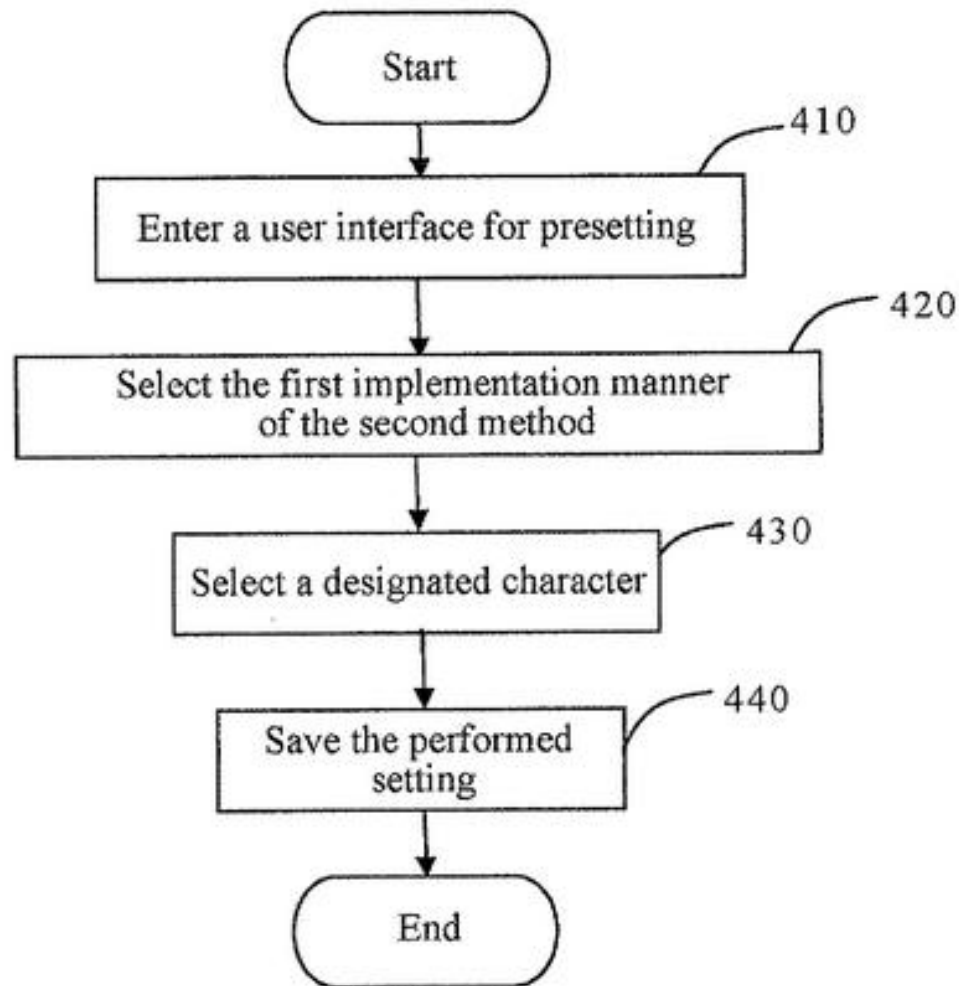

FIG. 3

# Example: Block Diagram Figure



# Filing: Provisional Application

- Required for Filing Date
  - Written Description & Necessary Drawings
- To Make Complete
  - Fee (\$130 or \$260)
  - Cover Sheet (inventors, title, corr. address)
- Optional
  - Formal Drawings
  - Claims
  - Assignment

# Filing: Non-provisional Application

- Required for Filing Date
  - Description & Claims (Spec), Drawings
- To Make Complete
  - Declaration
  - Fees (~\$730 or ~\$1,600)
  - Application Data Sheet (ADS) (inventors, priority)
- Optional
  - Assignment

# USPTO Forms

- [http://www.uspto.gov/forms/aia\\_for\\_ms.jsp](http://www.uspto.gov/forms/aia_for_ms.jsp)

<b>Appeal</b>	
<a href="#">AIA/31</a>	Notice of Appeal
<a href="#">AIA/32</a>	Request for Oral Hearing Before the Patent Trial and Appeal Board
<a href="#">AIA/33</a>	Pre-Appeal Brief Request for Review ( <a href="#">more information</a> )
<b>Application Data Sheet</b>	
<a href="#">AIA/14</a>	Application Data Sheet (37 CFR 1.76) ( <a href="#">instructions</a> / <a href="#">DOC</a> )
<b>Certificate of Mailing/Transmission</b>	
<a href="#">SB/92</a>	Certificate of Mailing under 37 CFR 1.8
<a href="#">SB/97</a>	Certificate of Transmission under 37 CFR 1.8
<b>Customer Number</b>	
<a href="#">SB/124</a>	Request for Customer Number Data Change
<a href="#">SB/125</a>	Request for Customer Number
<b>Express Abandonment</b>	
<a href="#">AIA/24</a>	Express Abandonment Under 37 CFR 1.138
<a href="#">AIA/24A</a>	Petition for Express Abandonment to Avoid Publication under 37 CFR 1.138(c)
<a href="#">AIA/24B</a>	Petition for Express Abandonment to Obtain a Refund
<b>Extended Missing Parts Pilot Program</b>	
<a href="#">AIA/421</a>	Certification and Request for Extended Missing Parts Pilot Program
<b>Fees</b>	
<a href="#">PTO-2038</a>	Credit Card Payment Form and Instructions
<a href="#">SB/06</a>	Patent Application Fee Determination Record
<a href="#">SB/07</a>	Multiple Dependent Claim Fee Calculation Sheet
<a href="#">SB/15A</a>	Certification of Micro Entity Status - Gross Income Basis ( <a href="#">Gross Income Limit</a> ) ( <a href="#">Who may sign the SB/15A and SB/15B?</a> )
<a href="#">SB/15B</a>	Certification of Micro Entity Status - Institution of Higher Education Basis ( <a href="#">Who may sign the SB/15A and SB/15B?</a> )
<a href="#">SB/17</a>	Fee Transmittal
<a href="#">SB/17i</a>	Processing Fee Under 37 CFR 1.17(i) Transmittal
<a href="#">AIA/17b</a>	Petition Fee Under 37 CFR 1.17(f), (g) & (h) Transmittal
<a href="#">SB/45</a>	Maintenance Fee Transmittal (to learn how to assert a change in small entity status when filing this form, please click <a href="#">here</a> )
<a href="#">SB/56</a>	Reissue Application Fee Transmittal
<a href="#">SB/91</a>	Deposit Account Order Form
<b>Information Disclosure Statement</b>	
<a href="#">SB08a</a>	Information Disclosure Statement by Applicant [page 1]
<a href="#">SB08b</a>	Information Disclosure Statement by Applicant [page 2]
<a href="#">SB08a - EFS-Web</a>	Information Disclosure Statement by Applicant [page 1] - EFS-Web auto-load version ( <a href="#">instructions</a> / <a href="#">DOC</a> )
<a href="#">SB09</a>	Certification and Request for Consideration of an Information Disclosure Statement Filed After Payment of the Issue Fee Under the QPIDS Pilot Program ( <a href="#">more information</a> )



# Provisional App. Cover Sheet

Doc Code: **TR.PROV**  
 Document Description: Provisional Cover Sheet (SB16)

PTO/SB/16 (11-08)  
 Approved for use through 05/31/2015. OMB 0651-0032  
 U.S. Patent and Trademark Office: U.S. DEPARTMENT OF COMMERCE

Under the Paperwork Reduction Act of 1995, no persons are required to respond to a collection of information unless it displays a valid OMB control number

Provisional Application for Patent Cover Sheet					
This is a request for filing a PROVISIONAL APPLICATION FOR PATENT under 37 CFR 1.53(c)					
<b>Inventor(s)</b>					
Inventor 1					Remove
Given Name	Middle Name	Family Name	City	State	Country j
All Inventors Must Be Listed – Additional Inventor Information blocks may be generated within this form by selecting the <b>Add</b> button.					Add
<b>Title of Invention</b>					
Attorney Docket Number (if applicable)					
<b>Correspondence Address</b>					
Direct all correspondence to (select one):					
<input checked="" type="radio"/> The address corresponding to Customer Number			<input type="radio"/> Firm or Individual Name		
Customer Number					

# Application Data Sheet (ADS)

PTO/AIA/14 (03-13)

Approved for use through 01/31/2014. OMB 0651-0032

U.S. Patent and Trademark Office; U.S. DEPARTMENT OF COMMERCE

Under the Paperwork Reduction Act of 1995, no persons are required to respond to a collection of information unless it contains a valid OMB control number.

<b>Application Data Sheet 37 CFR 1.76</b>	Attorney Docket Number	
	Application Number	
Title of Invention		
<p>The application data sheet is part of the provisional or nonprovisional application for which it is being submitted. The following form contains the bibliographic data arranged in a format specified by the United States Patent and Trademark Office as outlined in 37 CFR 1.76. This document may be completed electronically and submitted to the Office in electronic format using the Electronic Filing System (EFS) or the document may be printed and included in a paper filed application.</p>		

## Secrecy Order 37 CFR 5.2

Portions or all of the application associated with this Application Data Sheet may fall under a Secrecy Order pursuant to 37 CFR 5.2 (Paper filers only. Applications that fall under Secrecy Order may not be filed electronically.)

## Inventor Information:

<b>Inventor</b> 1	<input type="button" value="Remove"/>			
<b>Legal Name</b>				
<b>Prefix</b>	<b>Given Name</b>	<b>Middle Name</b>	<b>Family Name</b>	<b>Suffix</b>
<b>Residence Information (Select One)</b> <input checked="" type="radio"/> US Residency <input type="radio"/> Non US Residency <input type="radio"/> Active US Military Service				
<b>City</b>	<b>State/Province</b>	<b>Country of Residence</b>		
<b>Mailing Address of Inventor:</b>				
<b>Address 1</b>				
<b>Address 2</b>				

# Declaration

PTO/AIA/01 (06-12)

Approved for use through 01/31/2014. OMB 0651-0032

U.S. Patent and Trademark Office; U.S. DEPARTMENT OF COMMERCE

Under the Paperwork Reduction Act of 1995, no persons are required to respond to a collection of information unless it displays a valid OMB control number.

## DECLARATION (37 CFR 1.63) FOR UTILITY OR DESIGN APPLICATION USING AN APPLICATION DATA SHEET (37 CFR 1.76)

<b>Title of Invention</b>	
<p>As the below named inventor, I hereby declare that:</p> <p>This declaration is directed to: <input type="checkbox"/> The attached application, or</p> <p><input type="checkbox"/> United States application or PCT international application number <input style="width: 150px;" type="text"/></p> <p>filed on <input style="width: 150px;" type="text"/>.</p> <p>The above-identified application was made or authorized to be made by me.</p> <p>I believe that I am the original inventor or an original joint inventor of a claimed invention in the application.</p> <p>I hereby acknowledge that any willful false statement made in this declaration is punishable under 18 U.S.C. 1001 by fine or imprisonment of not more than five (5) years, or both.</p>	

# Information Disclosure Statement (IDS)

Doc code: IDS

Doc description: Information Disclosure Statement (IDS) Filed

PTO/SB/08a (01-10)

Approved for use through 07/31/2012. OMB 0651-0031

U.S. Patent and Trademark Office; U.S. DEPARTMENT OF COMMERCE

Under the Paperwork Reduction Act of 1995, no persons are required to respond to a collection of information unless it contains a valid OMB control number.

<b>INFORMATION DISCLOSURE STATEMENT BY APPLICANT</b> ( Not for submission under 37 CFR 1.99)	Application Number	
	Filing Date	
	First Named Inventor	
	Art Unit	
	Examiner Name	
	Attorney Docket Number	

U.S.PATENTS							Remove
Examiner Initial*	Cite No	Patent Number	Kind Code <sup>1</sup>	Issue Date	Name of Patentee or Applicant of cited Document	Pages,Columns,Lines where Relevant Passages or Relevant Figures Appear	
	1						
If you wish to add additional U.S. Patent citation information please click the Add button.							Add
U.S.PATENT APPLICATION PUBLICATIONS							Remove
Examiner Initial*	Cite No	Publication Number	Kind Code <sup>1</sup>	Publication Date	Name of Patentee or Applicant of cited Document	Pages,Columns,Lines where Relevant Passages or Relevant	

# Assignment

Application No.: 00/000000  
Filing Date: January 1, 2012

Docket Number: 000.000  
Page 1 of 3

## ASSIGNMENT

WHEREAS, John Doe, residing at Irvine, California, (individual(s) hereinafter "ASSIGNOR") invented certain new and useful improvements, technology, inventions, developments, ideas, ornamental design or discoveries related to Invention Name (collectively hereinafter referred to as the "Work") for which an application for Letters Patent in the United States has been prepared for filing (identified above) with the United States Patent and Trademark Office (hereinafter the "Application");

AND WHEREAS, Corporation, a Corporation, with its principal place of business at 100 Marketplace, Irvine, California (hereinafter the "ASSIGNEE"), desires to acquire the entire right, title, and interest in and to the Application and the Work:

### Application Information

NOW, THEREFORE, for good and valuable consideration, the receipt of which is hereby acknowledged, ASSIGNOR hereby acknowledges that ASSIGNOR has sold, assigned, transferred and set over, and by these presents does hereby sell, assign, transfer and set over, unto said ASSIGNEE, successors, legal representatives and assigns, the entire right, title, and interest throughout the world in the Application and the Work, including all provisional applications relating

# Assignment, cont.

Application No.: 00/000000  
Filing Date: January 1, 2012

Docket Number: 000.000  
Page 2 of 3

**Legal Name of inventor:**

Signature: \_\_\_\_\_ Date: \_\_\_\_\_

*Signature before a Notary is desirable but not required.*

STATE OF CALIFORNIA }  
COUNTY OF \_\_\_\_\_ } ss.

On \_\_\_\_\_, before me, \_\_\_\_\_, notary public, personally appeared who proved to me on the basis of satisfactory evidence to be the person(s) whose name(s) is/are subscribed to the within instrument, and acknowledged to me that he/she/they executed the same in his/her/their authorized capacity(ies), and that by his/her/their signature(s) on the instrument the person(s), or the entity upon behalf of which the person(s) acted, executed the instrument.

I certify under PENALTY OF PERJURY under the laws of the State of California that the foregoing paragraph is true and correct.

WITNESS my hand and official seal. \_\_\_\_\_

[SFAI 1

Notary Signature

# Before Filing

- Make sure the application has everything that you want in it
- Cannot add to or change the description after filing (although you can change the claims)
- Determine inventorship
- Convert all files to .pdf
- Prepare to pay fees with credit card
- File electronically at [www.uspto.gov](http://www.uspto.gov)

# Filing an Application - 1

**uspto.GOV**  
 The United States Patent and Trademark Office  
 an agency of the Department of Commerce

search for patents | search for trademarks

**PATENTS** | TRADEMARKS | IP LAW & POLICY | PRODUCTS & SERVICES | INVENTORS | NEWS & NOTICES | FAQs | ABOUT US

**USPTO Again Named to Top Places to Work in Federal Government**

The USPTO was named one of the federal government's Best Places to Work in 2012 by the non-profit Partnership for Public Service. The USPTO ranked 5th out of 292 federal agency subcomponents. In 2009, USPTO ranked 105th, then rose to 56th in 2010, and 19th in 2011.

**The Best Places to Work  
 IN THE FEDERAL GOVERNMENT.**

★ ★ ★ ★ ★ ★ ★

**Now Hiring**  
 Electrical, chemical, and mechanical disciplines

**America Invents Act**

**>> patents**  
 >> trademarks



# Filing an Application - 2

The screenshot shows the uspto.gov website. At the top, there is a search bar with the text "Search our site" and a green arrow button. Below the search bar, the text reads "The United States Patent and Trademark Office an agency of the Department of Commerce". A navigation bar contains links for PATENTS, TRADEMARKS, IP LAW & POLICY, PRODUCTS & SERVICES, INVENTORS, NEWS & NOTICES, FAQs, and ABOUT US. The main content area is titled "Patents" and includes a "What is a patent?" section with a definition and a "First-time filers, start here" section. There are also "Resources" for "Search Patents" and "PAIR". A red arrow on the right side of the page points downwards.

**uspto.GOV**  
 The United States Patent and Trademark Office  
 an agency of the Department of Commerce

search for patents | search for trademarks  
 Search our site

PATENTS | TRADEMARKS | IP LAW & POLICY | PRODUCTS & SERVICES | INVENTORS | NEWS & NOTICES | FAQs | ABOUT US

Home Page » PATENTS

**Patents**

**What is a patent?**

A patent is an intellectual property right granted by the Government of the United States of America to an inventor "to exclude others from making, using, offering for sale, or selling the invention throughout the United States or importing the invention into the United States" for a limited time in exchange for public disclosure of the invention when the patent is granted.

There are three types of patents. **Utility patents** may be granted to anyone who invents or discovers any new and useful process, machine, article of manufacture, or composition of matter, or any new and useful improvement thereof. Here is the **process for obtaining a utility patent**. **Design patents** may be granted to anyone who invents a new, original, and ornamental design for an article of manufacture. **Plant patents** may be granted to anyone who invents or discovers and asexually reproduces any distinct and new variety of plant.

View the different [types of patent applications](#).

**First-time filers, start here**

Learn general information about filing patents [online](#) or through this [downloadable and printable guide \(PDF\)](#).

**Resources**

**Search Patents**  
 Search for a patent, search patent owners (assignments), and our attorney database.

**PAIR**  
 Check the filing status of your patent application.

**Tools**

- Patent Search
- Patent Process
- Patent Classification
- Patent Forms
- Statistics
- Electronic Business Center
- Patent Laws, Regulations, Policies & Procedures
- Resources and Guidance
- Office of Data Management
- Announcements
- Initiatives & Events
- International Protection
- Employee Locator
- Contact Patents

# Filing an Application - 3

- Initiatives & Events
- International Protection
- Employee Locator
- Contact Patents

## Tools

- [Inventors Assistance Center \(IAC\)](#)
- [Electronic Filing System \(EFS-Web\)](#)
- [Patent Application Information Retrieval \(PAIR\)](#)
- [USPTO Patent Full-Text and Image Database \(PatFT\) and Application Full-Text and Image Database \(AppFT\)](#)
- [Publication Site for Issued and Published Sequences \(PSIPS\)](#)
- [Electronic Patent Assignment System \(EPAS\)](#)
- [Assignments on the Web for Patents \(AOTW-P\)](#)
- [Official Gazette \(Patents\)](#)
- [Federal Register Notices \(Patents\)](#)

## Popular Links

- [Organizational Charts](#)
- [Attorneys & Agents](#)
- [Forms](#)

## Resources



**Search Patents**

Search for a patent, search patent owners (assignments), and our attorney database.



**PAIR**

Check the filing status of your patent application.



**EFS-Web**

Submit your patent application or other related items.



**Inventor FAQs**

Read information for independent inventors.



**REVENUE ACCOUNTING AND MANAGEMENT**

Pay your patent maintenance fees and get patent bibliographic data.

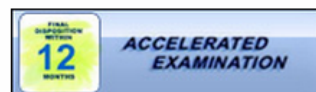

**ACCELERATED EXAMINATION**

Read about the USPTO's procedures for accelerating the examination of your patent application.

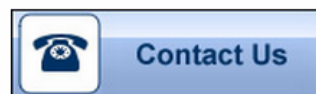

**Contact Us**

Contact Patents at the USPTO, individual technology centers, the ombudsman, and search for a USPTO employee.

## Patent Examiner Technical Training Program

The USPTO has instituted a Patent Examiner Technical Training Program which formalizes the process for seeking public

# Filing an Application - 4

uspto.GOV

[search for patents](#) | [search for trademarks](#)  
 ➔

The United States Patent and Trademark Office  
 an agency of the Department of Commerce

[PATENTS](#) | [TRADEMARKS](#) | [IP LAW & POLICY](#) | [PRODUCTS & SERVICES](#) | [INVENTORS](#) | [NEWS & NOTICES](#) | [FAQs](#) | [ABOUT US](#)

[Home Page](#) » [PATENTS](#) » [Patent Process](#) » [File Online](#) » EFS-Web

Patent Search

**Patent Process**

- [Search for Patents](#)
- [View Fee Schedule](#)
- **File Online**
  - **EFS-Web**
    - [Announcements](#)
    - [Resources](#)
    - [Accelerated Examination](#)
    - [First Action Interview](#)
    - [Patent Prosecution Highway](#)
    - [Priority Document Exchange](#)
  - [Check Status](#)
  - [Maintain/Pay Fees](#)
  - [Appeal \(PTAB\)](#)
  - [Change Ownership](#)

- [Patent Classification](#)
- [Patent Forms](#)
- [Statistics](#)

### About EFS-Web

EFS-Web is the United States Patent and Trademark Office's (USPTO's) Web-based patent application and document submission solution. Using EFS-Web, anyone with a Web-enabled computer can file patent applications and documents without downloading special software or changing document preparation tools and processes.

EFS-Web utilizes standard Web-based screens and prompts to enable you to submit patent application documents in PDF format directly to the USPTO within minutes. When creating your PDF documents, you choose the tool, process and workflow with which you author your documents, convert them to standard PDF files and then submit them to USPTO's secure servers. Additionally, EFS-Web allows submission of *PCT-EASY*.ZIP compressed files to submit International PCT applications and ASCII text files (.TXT) to submit your bio-sequence listings, computer program listings, mega tables, etc. EFS-Web is safe, simple and secure and gives you all of the same benefits as paper filings, including an electronic receipt that acknowledges your submission date.

- [Launch EFS-Web Registered eFiler](#) - for enhanced filing, follow-on processing, saved submissions and more
- **[Launch EFS-Web Unregistered eFiler](#)** - for basic initial filing of new patent applications
- [Launch EFS-Web Contingency Unregistered eFiler](#) - for basic initial filing of new patent applications when the primary portal to EFS-Web has an unscheduled outage
- [EFS-Web Announcements](#) - recent and archived announcements, links to view availability of business systems and alerts
- [EFS-Web Resources](#) - instructions for becoming a Registered eFiler, system requirements, EFS-Web eForms, and other useful information and links

  
**EFS-Web**

The Patent Electronic Business Center is open Monday - Friday, to help you with technical issues regarding EFS-Web. From 6:00 a.m. to 12 Midnight Eastern Time email [ebc@uspto.gov](mailto:ebc@uspto.gov) or call 866-217-9197.

# Filing an Application - 5

United States Patent and Trademark Office

Home | Site Index | Search | FAQ | Glossary | Guides | Contacts | eBusiness | eBiz Alerts | News | Help

Portal Home | Patents | Trademarks | Other

**Patent eBusiness**

- Electronic Filing
- Patent Application Information (PAIR)
- Patent Ownership
- Fees
- Supplemental Resources & Support

**Patent Information**

Patent Guidance and General Info

- Codes, Rules & Manuals
- Employee & Office Directories
- Resources & Public Notices

**Patent Searches**

- Patent Official Gazette
- Search Patents & Applications
- Search Biological Sequences
- Copies, Products & Services

**Other**

- Copyrights
- Trademarks
- Policy & Law
- Reports

**EFS Unregistered**

Unregistered efilers | Registered eFilers  | Please Read Announcements

**Welcome to Electronic Patent Filing for UNREGISTERED eFILERS**

**A submission has not been filed officially at the USPTO until the e-filer executes the Submit function and the documents are received at the USPTO Eastern Time. The Acknowledgement Receipt is evidence of this submission.**

All items denoted by \* are required.

**Advisory (29APR2013):** Due to maintenance, EFS-Web and Contingency will be unavailable 12:01 am until 4:00 am (ET) on Friday, May 3.

**Advisory (24APR2013):** When filing the Fee Transmittal (Part B) of the Notice of Allowance and Fee(s) Due form (PTOL-85b) via EFS-Web, please be sure that the second page of the 85b with the authorized signature is included.

**IMPORTANT:** Please read [Legal Framework for using EFS-Web](#). For information on the Paperwork Reduction Act as it pertains to third party submissions under 37 CFR 1.290, please see the [OMB Clearance and PRA Burden Statement - Third Party Submissions page](#)

**Sign-on as an UNREGISTERED eFILER**

\* e-Filer Last Name:

\* e-Filer First Name:

e-Filer E-Mail Address:

\*Main Functions

New application/proceeding

*(This includes new filings of continuation, divisional, continuation-in-part and reissue applications, as well as reexamination and supplemental examination proceedings. A request for continued examination (RCE) and continued prosecution application (CPA) are considered existing documents and must be filed as a registered eFiler.)*

Existing application/patent

[Privacy Policy](#)

**If you close or exit the eFiling portal you will lose your work.**

*For your convenience, all links in the left hand side of the eFiling portal will open in new windows to help prevent accidental loss of information during filing.*

*Context-sensitive help (information graphic links) will appear in a new window.*

# Filing an Application - 6

**Patent Searches**

[Patent Official Gazette](#)

[Search Patents & Applications](#)

[Search Biological Sequences](#)

[Copies, Products & Services](#)

---

**Other**

[Copyrights](#)

[Trademarks](#)

[Policy & Law](#)

[Reports](#)

... information on the eFiling portal, please see the [OMB Clearance and PRA Burden Statement - Third Party Submissions page](#)

---

**Sign-on as an UNREGISTERED eFILER**

\* e-Filer Last Name:

\* e-Filer First Name:

\* e-Filer E-Mail Address:

\*Main Functions:

New application/proceeding

*(This includes new filings of continuation, divisional, continuation-in-part and reissue applications, as well as reexamination and supplemental examination proceedings. A request for continued examination (RCE) and continued prosecution application (CPA) are considered existing documents and must be filed as a registered eFiler.)*

\*Select Type of New Application/Proceeding

Utility (Please select a type below) i

**NEW** Track I Prioritized Examination - Nonprovisional Application under 35 USC 111(a) i

Accelerated Exam i

Nonprovisional Application under 35 USC 111(a) i

Provisional i

Reexam i

Reissue i

U.S. National Stage under 35 USC 371 i

Design (Please select a type below) i

International Application for filing in the US receiving office i

Supplemental Examination (of Utility, Design, Plant, or Reissue) i

Existing application/patent i

[Privacy Policy](#)

**If you close or exit the eFiling portal you will lose your work.**  
 For your convenience, all links in the left hand side of the eFiling portal will open in new windows to help prevent accidental loss of information

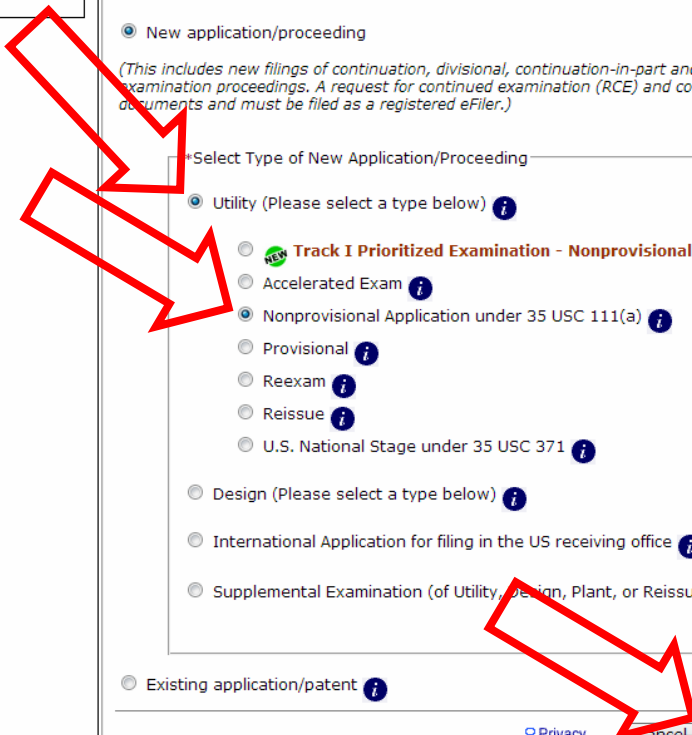

# Filing an Application - 7

**United States Patent and Trademark Office**  
[Home](#) | [Site Index](#) | [Search](#) | [FAQ](#) | [Glossary](#) | [Guides](#) | [Contacts](#) | [eBusiness](#) | [eBiz Alerts](#) | [News](#) | [Help](#)

Portal Home | Patents | Trademarks | Other

---

**Patent eBusiness**

- [Electronic Filing](#)
- [Patent Application Information \(PAIR\)](#)
- [Patent Ownership](#)
- [Fees](#)
- [Supplemental Resources & Support](#)

**Patent Information**

- [Patent Guidance and General Info](#)
- [Codes, Rules & Manuals](#)
- [Employee & Office Directories](#)
- [Resources & Public Notices](#)

**Patent Searches**

- [Patent Official Gazette](#)
- [Search Patents & Applications](#)
- [Search Biological Sequences](#)
- [Copies, Products & Services](#)

**Other**

- [Copyrights](#)
- [Trademarks](#)
- [Policy & Law](#)
- [Reports](#)

**EFS Unregistered**

Unregistered eFilers | Please Read Announcements | Application Data | Attach Documents | Review Documents | Calculate Fees | Confirm & Submit | Pay Fees | Receipt

**Application Data**

A submission has not been filed officially at the USPTO until the e-filer executes the Submit function and the documents are received at the USPTO Eastern Time. The Acknowledgment Receipt is evidence of this submission.  
All items denoted by \* are required.

\* Title of Invention:

Attorney Docket Number:

**First Named Inventor:**

\*First Name:

Middle Name:

\* Last Name:

**Correspondence Address:**

Enter a customer number for correspondence or provide an address where USPTO should send correspondence for this application.

**Customer Number** \* Please enter a valid Customer Number  
OR

**Correspondence Address**

[Privacy Policy](#)

*If you need help:*

- To ask questions about Patent e-Filing, or to suggest improvements to the online system, please call the Patent Electronic Business Center at (866) 217-9197 (toll free) or send email to [EBC@uspto.gov](mailto:EBC@uspto.gov).
- Send general questions about USPTO programs to the [USPTO Contact Center \(UCC\)](#).
- If you experience technical difficulties or problems with this application, please report them via e-mail to [Electronic Business Support](#) or call 1 800-786-9199.
- For general questions regarding a petition, or requirements for filing a petition, contact the Office of Petitions Help Desk at 1 800-786-9199.

# Filing an Application - 8

**Patent Searches**

- [Patent Official Gazette](#)
- [+ Search Patents & Applications](#)
- [+ Search Biological Sequences](#)
- [+ Copies, Products & Services](#)

**Other**

- [Copyrights](#)
- [Trademarks](#)
- [Policy & Law](#)
- [Reports](#)

Attorney Contact Number  

---

**First Named Inventor:** 

\*First Name

Middle Name

\* Last Name

---

**Correspondence Address:** 

Enter a customer number for correspondence or provide an address where USPTO should send correspondence for this application.

Customer Number  
 OR  
 Correspondence Address

If you do not have a customer number, please provide a correspondence address.

\*Name 1

Name 2

\*Street Address 1

Street Address 2

\* City

State

\*Country



Postal Code

Telephone Number

e-Mail Address

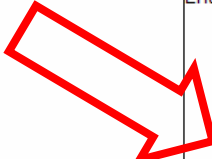

*If you need help:*

# Filing an Application - 9

**United States Patent and Trademark Office**  
 Home | Site Index | Search | FAQ | Glossary | Guides | Contacts | eBusiness | eBiz Alerts | News | Help

Portal Home | Patents | Trademarks | Other

**Patent eBusiness**

- Electronic Filing
- Patent Application Information (PAIR)
- Patent Ownership
- Fees
- Supplemental Resources & Support

**Patent Information**

- Patent Guidance and General Info
- Codes, Rules & Manuals
- Employee & Office Directories
- Resources & Public Notices

**Patent Searches**

- Patent Official Gazette
- Search Patents & Applications
- Search Biological Sequences
- Copies, Products & Services

**Other**

- Copyrights
- Trademarks
- Policy & Law Reports

**EFS Unregistered**

Unregistered eFilers | Please Read Announcements | Application Data | Attach Documents | Review Documents | Calculate Fees | Confirm & Submit | Pay Fees | Receipt

**Attach Documents**

A submission has not been filed officially at the USPTO until the e-filer executes the Submit function and the documents are received at the USPTO Eastern Time. The Acknowledgement Receipt is evidence of this submission.

Applicants are strongly urged to timely file the Certification and Authorization form PTO/SB/69 (available at <http://www.uspto.gov/forms/sb0069.pdf>) in each nonprovisional application that is intended to form the basis for a priority claim in a subsequent application filed with the EPO.

**This is the application data associated with your filing. If any information is incorrect, please edit the [Application Data](#)**

Title of Invention	MY NEW INVENTION
First Named Inventor	John Doe
Customer Number or Correspondence Address	John Doe 1 Example St. Town CA US
Filed By	Scott Cromar
Attorney Docket Number	
Application Type	Utility under 35 USC 111(a)

**Files to be Submitted** | **Category** | **Document Description**

1  No file chosen

Does your PDF file contain multiple documents?  Yes  No

Users are advised not to submit credit card payment form PTO-2038 via EFS-Web. Submission of the credit card payment form via EFS-Web may result in the form being included among the patent or trademark records open for public inspection. Users choosing to pay with a credit card should instead utilize the on-line payment method available through EFS-Web.

If you need help: Please Upload & Validate before Review



# Filing an Application - 10

**United States Patent and Trademark Office**  
 Home | Site Index | Search | FAQ | Glossary | Guides | Contacts | eBusiness | eBiz Alerts | News | Help

Portal Home | Patents | Trademarks | Other

**Patent eBusiness**

- Electronic Filing
- Patent Application Information (PAIR)
- Patent Ownership
- Fees
- Supplemental Resources & Support

**Patent Information**

- Patent Guidance and General Info
- Codes, Rules & Manuals
- Employee & Office Directories
- Resources & Public Notices

**Patent Searches**

- Patent Official Gazette
- Search Patents & Applications
- Search Biological Sequences
- Copies, Products & Services

**Other**

- Copyrights
- Trademarks
- Policy & Law
- Reports

**EFS Unregistered**

Unregistered eFilers | Please Read Announcements | Application Data | Attach Documents | Review Documents | Calculate Fees | Confirm & Submit | Pay Fees | Receipt

**Attach Documents**

A submission has not been filed officially at the USPTO until the e-filer executes the Submit function and the documents are received at the USPTO Eastern Time. The Acknowledgement Receipt is evidence of this submission.

Applicants are strongly urged to timely file the Certification and Authorization form PTO/SB/69 (available at <http://www.uspto.gov/forms/sb0069.pdf>) in each nonprovisional application that is intended to form the basis for a priority claim in a subsequent application filed with the EPO.

**This is the application data associated with your filing. If any information is incorrect, please edit the [Application Data](#)**

Title of Invention	MY NEW INVENTION
First Named Inventor	John Doe
Customer Number or Correspondence Address	John Doe 1 Example St. Town CA US
Filed By	Scott Cromar
Attorney Docket Number	
Application Type	Utility under 35 USC 111(a)

Files to be Submitted	Category	Document Description
1 <input type="button" value="Choose File"/> Application.pdf	Application Part	<input type="text"/> <input type="button" value="Delete"/>
Does your PDF file contain multiple documents?		
<input type="button" value="Add File"/>		
<p><i>Users are advised not to submit credit card payments being included among the patent or trademark records method available through EFS-Web.</i></p> <p><i>Submission of the credit card payment form via EFS-Web may result in the form choosing to pay with a credit card should instead utilize the on-line payment</i></p> <p><input type="button" value="Review"/> &amp; Validate <input type="button" value="Review"/></p> <p>before Review</p>		

If you need help:

- To ask questions about Patent e-Filing, or to suggest improvements to the online system, or report technical problems, please call the Patent Electronic Business Center at (866) 217-9197 (toll free) or send email to [EB@uspto.gov](mailto:EB@uspto.gov).
- Send general questions about USPTO programs to the [USPTO Contact Center \(UCC\)](#).
- For general questions regarding a petition, or requirements for filing a petition, contact the Office of Petitions Help Desk at 1 800-786-9199.

# Filing an Application - 11

**United States Patent and Trademark Office**  
 Home | Site Index | Search | FAQ | Glossary | Guides | Contacts | eBusiness | eBiz Alerts | News | Help

Portal Home | Patents | Trademarks | Other

**Patent eBusiness**

- Electronic Filing
- Patent Application Information (PAIR)
- Patent Ownership
- Fees
- Supplemental Resources & Support

**Patent Information**

- Patent Guidance and General Info
- Codes, Rules & Manuals
- Employee & Office Directories
- Resources & Public Notices

**Patent Searches**

- Patent Official Gazette
- Search Patents & Applications
- Search Biological Sequences
- Copies, Products & Services

**Other**

- Copyrights
- Trademarks
- Policy & Law
- Reports

**EFS Unregistered**

Unregistered eFilers | Please Read Announcements | Application Data | Attach Documents | Review Documents | Calculate Fees | Confirm & Submit | Pay Fees | Receipt

**Attach Documents**

A submission has not been filed officially at the USPTO until the e-filer executes the Submit function and the documents are received at the USPTO Eastern Time. The Acknowledgement Receipt is evidence of this submission.

Applicants are strongly urged to timely file the Certification and Authorization form PTO/SB/69 (available at <http://www.uspto.gov/forms/sb0069.pdf>) in each nonprovisional application that is intended to form the basis for a priority claim in a subsequent application filed with the EPO.

This is the application data associated with your filing. If any information is incorrect, please edit the [Application Data](#)

Title of Invention	MY NEW INVENTION
First Named Inventor	John Doe
Customer Number or Correspondence Address	John Doe 1 Example St. Town CA US
Filed By	Scott Cromar
Attorney Docket Number	
Application Type	Utility under 35 USC 111(a)

Files to be Submitted	Category	Document Description
1 Choose File Application.pdf Does your PDF file contain multiple documents? <input type="radio"/> Yes <input checked="" type="radio"/> No	Application Part	<ul style="list-style-type: none"> <li>Affidavit-not covered under specific rule</li> <li>Affidavit-traversing rejects or objects rule 132</li> <li>Appendix to the Specification</li> <li>Application Data Sheet</li> <li>Chemical Formulae (Text File)</li> <li>Claims</li> <li>Computer Listing (text file)</li> <li>Drawings-only black and white line drawings</li> <li>Drawings-other than black and white line drawings</li> <li>Make/Rescind statement under 37 CFR 1.55/1.78</li> <li>Mathematical Formulae (Text File)</li> <li>Oath or Declaration filed</li> <li>Sequence Listing</li> <li>Sequence Listing (Text File)</li> <li>Specification</li> <li>Specification - Not in English</li> <li>Statutory disclaimers per MPEP 1490.</li> <li>Table not included in SPEC (Text File)</li> <li>Terminal Disclaimer Filed</li> <li>Translation of Foreign Priority Documents</li> </ul>

Users are advised not to submit credit card payment form PTO-2038 via EFS-Web. Submission being included among the patent or trademark records open for public inspection. Users choose method available through EFS-Web.

If you need help: [Privacy Policy](#)

To ask questions about Patent e-Filing, or to suggest improvements to the online system, contact the Patent e-Filing Center at (866) 217-9197 (toll free) or send email to [EBC@uspto.gov](mailto:EBC@uspto.gov).  
 Send general questions about USPTO programs to the [USPTO Contact Center \(USPTO\)](#).  
 For general questions regarding a petition, or requirements for filing a petition, contact the [Petition Center](#).

You can suggest USPTO webpages or material you would like featured on this section by E-mail to the [webmaster@uspto.gov](mailto:webmaster@uspto.gov). While we cannot promise to accommodate all requests, your suggestions will be considered and may lead to other improvements on the website.

# Filing an Application - 12

**United States Patent and Trademark Office**  
 Home | Site Index | Search | FAQ | Glossary | Guides | Contacts | eBusiness | eBiz Alerts | News | Help

Portal Home | Patents | Trademarks | Other

**Patent eBusiness**

- Electronic Filing
- Patent Application Information (PAIR)
- Patent Ownership
- Fees
- Supplemental Resources & Support

**Patent Information**

- Patent Guidance and General Info
- Codes, Rules & Manuals
- Employee & Office Directories
- Resources & Public Notices

**Patent Searches**

- Patent Official Gazette
- Search Patents & Applications
- Search Biological Sequences
- Copies, Products & Services

**Other**

- Copyrights
- Trademarks
- Policy & Law
- Reports

**EFS Unregistered**

Unregistered eFilers | Please Read Announcements | Application Data | Attach Documents | Review Documents | Calculate Fees | Confirm & Submit | Pay Fees | Receipt

**Attach Documents**

A submission has not been filed officially at the USPTO until the e-filer executes the Submit function and the documents are received at the USPTO Eastern Time. The Acknowledgement Receipt is evidence of this submission.

Applicants are strongly urged to timely file the Certification and Authorization form PTO/SB/69 (available at <http://www.uspto.gov/forms/sb0069.pdf>) in each nonprovisional application that is intended to form the basis for a priority claim in a subsequent application filed with the EPO.

**This is the application data associated with your filing. If any information is incorrect, please edit the [Application Data](#)**

Title of Invention	MY NEW INVENTION
First Named Inventor	John Doe
Customer Number or Correspondence Address	John Doe 1 Example St. Town CA US
Filed By	Scott Cromar
Attorney Docket Number	
Application Type	Utility under 35 USC 111(a)

Files to be Submitted	Category	Document Description
1 <input type="button" value="Choose File"/> Application.pdf	Application Part	Specification

Does your PDF file contain multiple documents?  Yes  No

*Users are advised not to submit credit card payment form PTO-2038 via EFS-Web. Submission of the credit card payment form via EFS-Web may result in the form being included among the patent or trademark records open for public inspection. Users choosing to pay with a credit card should instead utilize the on-line payment method available through EFS-Web.*

*If you need help:* Please Upload & Validate before Review

- To ask questions about Patent e-Filing, or to suggest improvements to the online system, or report technical problems, please call the Patent Electronic Business Center at (866) 217-9197 (toll free) or send email to [EBC@uspto.gov](mailto:EBC@uspto.gov).
- Send general questions about USPTO programs to the [USPTO Contact Center \(UCC\)](#).
- For general questions regarding a petition, or requirements for filing a petition, contact the Office of Petitions Help Desk at 1 800-786-9199.

# Filing an Application - 13

United States Patent and Trademark Office

Home | Site Index | Search | FAQ | Glossary | Guides | Contacts | eBusiness | eBiz Alerts | News | Help

Portal Home | Patents | Trademarks | Other

**Patent eBusiness**

- Electronic Filing
- Patent Application Information (PAIR)
- Patent Ownership
- Fees
- Supplemental Resources & Support

**Patent Information**

- Patent Guidance and General Info
- Codes, Rules & Manuals
- Employee & Office Directories
- Resources & Public Notices

**Patent Searches**

- Patent Official Gazette
- Search Patents & Applications
- Search Biological Sequences
- Copies, Products & Services

**Other**

- Copyrights
- Trademarks
- Policy & Law
- Reports

**EFS Unregistered**

Unregistered eFilers | Please Read Announcements | Application Data | Attach Documents | Review Documents | Calculate Fees | Confirm & Submit | Pay Fees | Receipt

**Review Documents**

A submission has not been filed officially at the USPTO until the e-filer executes the Submit function and the documents are received at the USPTO Eastern Time. The Acknowledgement Receipt is evidence of this submission.

This is the application data associated with your filing. If any information is incorrect, please edit the [Application Data](#)

Title of Invention	MY NEW INVENTION
First Named Inventor	John Doe
Customer Number or Correspondence Address	John Doe 1 Example St. Town CA US
Filed By	Scott Cromar
Attorney Docket Number	
Application Type	Utility under 35 USC 111(a)

To Review a Document, please click on the document name. To add more files please [Attach Files](#)

Validation Status	Files to be Submitted	Multi-Doc PDF	Document Description	Page Count	Size	
PASS	<a href="#">Application.pdf</a>	NO	Specification	1	11043 bytes	<a href="#">Edit</a> <a href="#">Remove</a>

◆ No validation errors found.

[Privacy Policy](#) [Cancel](#) [Attach Files](#) [Revalidate](#) [Continue](#)

◆ No Error(s) ▲ Warning(s) ▼ Error(s) found

If you need help:

- To ask questions about Patent e-Filing, or to suggest improvements to the online system, or report technical problems, please call the Patent Electronic Business Center at (866) 217-9197 (toll free) or send email to [EBC@uspto.gov](mailto:EBC@uspto.gov).
- Send general questions about USPTO programs to the [USPTO Contact Center \(UCC\)](#).

# Filing an Application - 14

- [Fees](#)
- [Supplemental Resources & Support](#)
- Patent Information**
- [Patent Guidance and General Info](#)
- [Codes, Rules & Manuals](#)
- [Employee & Office Directories](#)
- [Resources & Public Notices](#)
- Patent Searches**
- [Patent Official Gazette](#)
- [Search Patents & Applications](#)
- [Search Biological Sequences](#)
- [Copies, Products & Services](#)
- Other**
- [Copyrights](#)
- [Trademarks](#)
- [Policy & Law Reports](#)

If you are not paying fees for this filing at this time, you may continue to [Confirm/Submit](#)

Failure to pay these fees on filing a new application will result in a surcharge. See [37 CFR 1.16 \(f\) and \(g\)](#).

**A submission has not been filed officially at the USPTO until the e-filer executes the Submit function and the documents are received at the USPTO Eastern Time. The Acknowledgement Receipt is evidence of this submission.**

**Fees Displayed: Small Entity**  
**Entity Status for Fee Purposes:** [Regular Undiscounted](#) [Small Entity](#) [Micro Entity](#)

---

**Fee Calculator**

Total Fees Due: \$

**Utility Patent Application Filing Fees** (select all that apply)

<input checked="" type="checkbox"/> Filing	<input checked="" type="checkbox"/> Search	<input checked="" type="checkbox"/> Exam	
Amount	\$70	\$300	\$360
Fee Code	4011	2111	2311
			Sub-Total \$ <input type="text" value="730"/>

**Application Size Fee - Number of Pages in the Specification (including any external tables) and drawings** ⓘ

Was this application originally filed in paper?  Yes  No

Number of Pages  \* .75 =  -100 =  / 50 =  \* \$ 200 = Sub-Total \$

**Claims** (select all that apply)

Claims in excess of twenty  \* \$40 = \$

Independent claims in excess of three  \* \$210 = \$

Multiple Dependent Claims(\$390) = \$  Sub-Total \$

**Miscellaneous Fees:** (select all that apply)

Non-English Specification (\$ 70)

Publication Fee for early, voluntary or normal publication (\$ 300) ⓘ  
*The publication fee for normal publication is not due until the application is allowed. Requests for early publication must include a separate statement requesting early publication.*

Surcharge - Late filing fee, search fee, examination fee or oath or declaration (\$ 70)

Sub-Total \$

**Petition Filing Fees** (select all that apply)

[Privacy Policy](#)

If you need help:

# Filing an Application - 15

**Patent eBusiness**

- Electronic Filing
- Patent Application Information (PAIR)
- Patent Ownership
- Fees
- Supplemental Resources & Support

**Patent Information**

- Patent Guidance and General Info
- Codes, Rules & Manuals
- Employee & Office Directories
- Resources & Public Notices

**Patent Searches**

- Patent Official Gazette
- Search Patents & Applications
- Search Biological Sequences
- Copies, Products & Services

**Other**

- Copyrights
- Trademarks
- Policy & Law
- Reports

**EFS Unregistered**

Unregistered eFilers
Please Read Announcements
Application Data
Attach Documents
Review Documents
Calculate Fees
Confirm & Submit
Pay Fees
Receipt

**Submit Application**

A submission has not been filed officially at the USPTO until the e-filer executes the Submit function and the documents are received at the USPTO Eastern Time. The Acknowledgement Receipt is evidence of this submission.

This is the application data associated with your submission. If any information is incorrect, please edit the [Application Data](#)

Title of Invention	MY NEW INVENTION
First Named Inventor	John Doe
Customer Number or Correspondence Address	John Doe 1 Example St. Town CA US
Filed By	Scott Cromar
Attorney Docket Number	
Application Type	Utility under 35 USC 111(a)

This is the fee data associated with your submission. If the following amount is incorrect, please edit the [Fee Calculation](#)

Total Fees Due: \$ 730

To Review a Document, please click on the document name.

Sequence	Files to be Submitted	Page Count	Document Description	File Size	Validation Status Message
1	<a href="#">Application.pdf</a>	1	Specification	11043 byte	PASS
	◆ No validation errors found.				
2	<a href="#">fee-info.pdf</a>	2	Fee Worksheet (SB06)	32174 byte	PASS
	◆ No validation errors found.				

[Edit Attached Files](#)

Please click Submit only once

If you need help:

- To ask questions about Patent e-Filing, or to suggest improvements to the online system, please call the Patent Electronic Business Center at (866) 217-9197

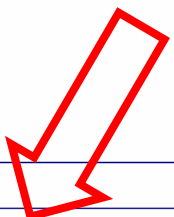
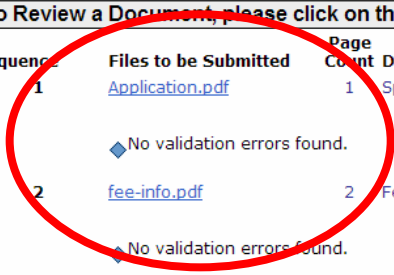

## Filing an Application - 16

- Then you may pay the fees with a credit card
  - May elect to pay fees later
- Download electronic filing acknowledgment
- Will get a filing date as long as you include specification, drawings, and at least one claim
- My receive Notice of Missing Parts if problem with declaration or fee payment

# Filing an Application - 17

- Other docs you may wish to file:
  - Micro Entity Statement
  - Declaration
  - Assignment
  - Information Disclosure Statement (IDS)
    - Disclose any prior art references that may be material to patentability



# After Filing

# Office Actions

- Identifies specific rejections or objections to claims or specification based on formalities or prior art
- 3-6 month period for reply
- Argue and/or amend claims

# Office Actions

<b>Office Action Summary</b>	Application No.	Applicant(s)	
	10/619,938	BECK ET AL.	
	Examiner	Art Unit	
	Brent S. Stace	2161	

**-- The MAILING DATE of this communication appears on the cover sheet with the correspondence address --**

**Period for Reply**

A SHORTENED STATUTORY PERIOD FOR REPLY IS SET TO EXPIRE 3 MONTH(S) OR THIRTY (30) DAYS, WHICHEVER IS LONGER, FROM THE MAILING DATE OF THIS COMMUNICATION.

- Extensions of time may be available under the provisions of 37 CFR 1.136(a). In no event, however, may a reply be timely filed after SIX (6) MONTHS from the mailing date of this communication.
- If NO period for reply is specified above, the maximum statutory period will apply and will expire SIX (6) MONTHS from the mailing date of this communication.
- Failure to reply within the set or extended period for reply will, by statute, cause the application to become ABANDONED. (35 U.S.C. § 133). Any reply received by the Office later than three months after the mailing date of this communication, even if timely filed, may reduce any earned patent term adjustment. See 37 CFR 1.704(b).

**Status**

1)  Responsive to communication(s) filed on 24 May 2007.

2a)  This action is **FINAL**.                      2b)  This action is non-final.

3)  Since this application is in condition for allowance except for formal matters, prosecution as to the merits is closed in accordance with the practice under *Ex parte Quayle*, 1935 C.D. 11, 453 O.G. 213.

**Disposition of Claims**

4)  Claim(s) 1-30,36-46 and 51 is/are pending in the application.

    4a) Of the above claim(s) \_\_\_\_\_ is/are withdrawn from consideration.

5)  Claim(s) \_\_\_\_\_ is/are allowed.

6)  Claim(s) 1-30,36-46 and 51 is/are rejected.

7)  Claim(s) \_\_\_\_\_ is/are objected to.

8)  Claim(s) \_\_\_\_\_ are subject to restriction and/or election requirement.

10. The following is a quotation of the appropriate paragraphs of 35 U.S.C. 102 that form the basis for the rejections under this section made in this Office action:

A person shall be entitled to a patent unless –

(e) the invention was described in (1) an application for patent, published under section 122(b), by another filed in the United States before the invention by the applicant for patent or (2) a patent granted on an application for patent by another filed in the United States before the invention by the applicant for patent, except that an international application filed under the treaty defined in section 351(a) shall have the effects for purposes of this subsection of an application filed in the United States only if the international application designated the United States and was published under Article 21(2) of such treaty in the English language.

11. Claims 36, 37, 40, and 42-44 are rejected under 35 U.S.C. 102(e) as being anticipated by U.S. Patent No. 6,571,236 (Ruppelt).

**Claim 36** can be mapped to Ruppelt as follows: “A method of targeting an online site or document to a user based on the user’s responses to questions, [Ruppelt, col. 1, lines 6-12 with Ruppelt, col. 2, lines 65-67 with Ruppelt, col. 3, lines 1-7 with Ruppelt, col. 3, lines 21-34 with Ruppelt, col. 4, lines 7-17] the method comprising:

***Claim Rejections - 35 USC § 103***

12. The following is a quotation of 35 U.S.C. 103(a) which forms the basis for all obviousness rejections set forth in this Office action:

(a) A patent may not be obtained though the invention is not identically disclosed or described as set forth in section 102 of this title, if the differences between the subject matter sought to be patented and the prior art are such that the subject matter as a whole would have been obvious at the time the invention was made to a person having ordinary skill in the art to which said subject matter pertains. Patentability shall not be negated by the manner in which the invention was made.

13. Claims 1, 2, 4, 5, 10-12, 17, 18, and 30 are rejected under 35 U.S.C. 103(a) as being unpatentable over U.S. Patent No. 6,571,236 (Ruppelt) in view of U.S. Patent No. 6,393,581 (Friedman et al.).

For **Claim 1**, Ruppelt teaches: "A method of generating a search engine query for locating an online site in response to user responses to one or more questions, [Ruppelt, col. 1, lines 6-12 with Ruppelt, col. 2, lines 65-67 with Ruppelt, col. 3, lines 21-34 with Ruppelt, col. 4, lines 7-17] the method comprising:

# Office Action Response

- Anticipation (35 U.S.C. § 102)
  - “for anticipation . . . the reference must teach every aspect of the claimed invention either explicitly or impliedly.” M.P.E.P. 706.02
- Obviousness (35 U.S.C. § 103)
  - “references must ... suggest the claimed invention or the examiner must present a convincing line of reasoning as to why the artisan would have found the claimed invention to have been obvious in light of the teachings of the references” M.P.E.P. 706.02(j)
- Per statute: 6 months
- Shortened statutory period: 3 months
- Graduated extension fees required after 3 months.

# Examiner Interviews

- For non-provisional applications, typically must wait until after first Office Action is received
- Telephonic or face-to-face
- Face-to-face interviews are typically more effective in
  - advancing patent applications towards issuance
  - Establishing relationship with Examiner
    - Examiner may be more cooperative during and after the Interview
- All applications may be interviewed
  - Especially important applications

# Considerations for Hiring an Attorney



# Hiring an Attorney

- **Cost**
- **Technology and Complexity**
- **Status of Prosecution**

Russell Jeide [russell.jeide@knobbe.com](mailto:russell.jeide@knobbe.com)

Scott Cromar [scott.cromar@knobbe.com](mailto:scott.cromar@knobbe.com)



Orange County



San Diego



San Francisco

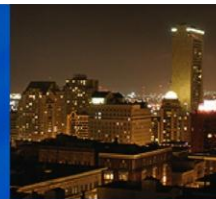

Silicon Valley

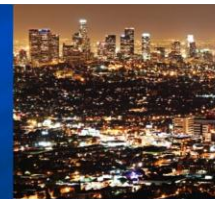

Los Angeles

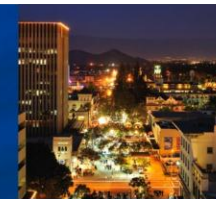

Riverside



Seattle

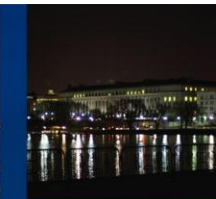

Washington DC